

PRZEKRÓJ M-M  
SKALA 1 : 6

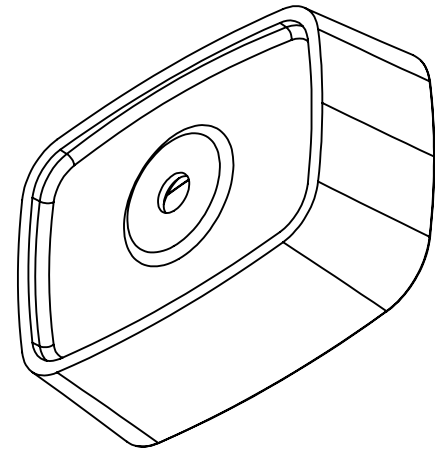
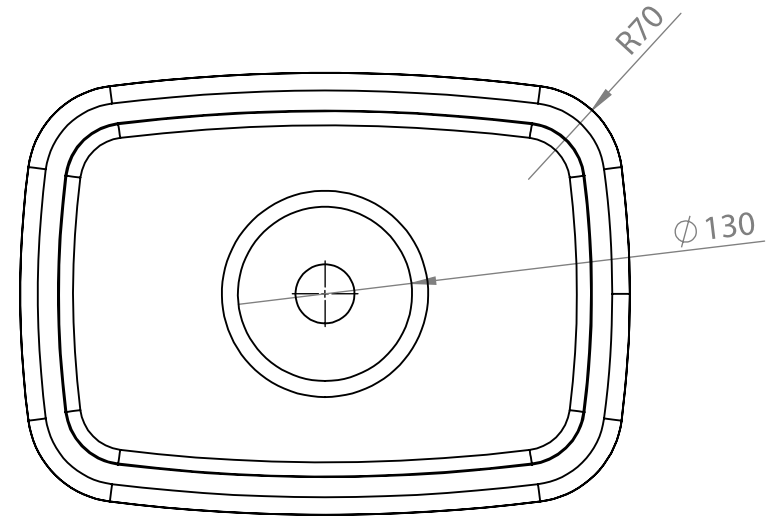

PRZEKRÓJ N-N  
SKALA 1 : 6